



**WAUPACA**  
**ELEVATOR** COMPANY, INC.  
Specify the Specialists®

---

# Owner's Guide

---

**Paca-Lift**  
**Elevator**



***Congratulations*** on your choice of a Waupaca Elevator Paca-Lift.

Your Paca-Lift is manufactured in accordance with the National Elevator Code A17.1 - 2004.

Properly used and maintained, your new elevator will give you many years of excellent service. However, you must be sure to follow all safety procedures.

This Owner's Guide should be reviewed periodically and saved for future reference.



We are a proud member of the Accessibility Equipment Manufacturers Association. This symbol assures you of our commitment to high quality and accessibility to everyone.

## Table of Contents

Introduction .....	4
Serial Number .....	4
Maintenance and Service .....	4
Important Operating Notes .....	5
Safety Features .....	6
Basic Operating Instructions .....	7
Descriptive Features .....	8
Troubleshooting .....	10
Emergency Procedures .....	11
Limited Warranty .....	14

---

## Introduction

Your Dealer will instruct you on the proper and safe operation of your Waupaca Paca-Lift Elevator. **IT IS IMPORTANT THAT YOU READ THIS OWNER'S GUIDE CAREFULLY BEFORE USING YOUR NEW ELEVATOR.**

Your elevator was designed for years of dependable service. However, as with all electrical and mechanical equipment, proper operation and periodic maintenance is absolutely required. Maintenance instructions are available and are to be used by qualified personnel only. We recommend you establish a maintenance agreement with your elevator contractor.

---

## Elevator Serial Number

This serial number contains specific information about your elevator, allowing technicians to properly identify replacement parts.

---

## Maintenance and Service

### Elevator Contractor Information

Company: \_\_\_\_\_

Address: \_\_\_\_\_

\_\_\_\_\_  
\_\_\_\_\_

Contact Name: \_\_\_\_\_

Telephone No. \_\_\_\_\_

















If you have questions concerning the operation or maintenance requirements of your elevator, please contact the local elevator contractor listed above. We suggest you develop an ongoing relationship with your contractor for routine servicing and periodic maintenance. Do not try to service or repair your Paca-Lift elevator yourself.

---

# Important Operating Notes



Designates a condition where failure to follow instructions or heed warning could result in serious personal injury or death. When you see this symbol **HEED ITS MESSAGE.**

-  Anyone planning on using this elevator must be trained in its proper use and have read this owner's guide.
-  Always verify the elevator has properly leveled at the landing (to avoid tripping or falling) before entering or exiting the car.
-  Do not lean against the elevator gate or the control panel.
-  Do not allow unsupervised children to use this elevator.
-  Do not attempt to bypass, or otherwise tamper with, any of the safety systems.
-  Do not exceed maximum capacity of the elevator. A capacity tag is posted in the car.
-  Never open a gate, or hoistway door, while the elevator is in motion (it will stop the elevator).
-  Do not use your elevator to transport freight.
-  If you detect a problem with your elevator, do not use it. Call your elevator contractor immediately.
-  Do not use this elevator in the event of fire or smoke in the residence.
-  Avoid using your elevator during severe weather conditions or when there is a strong possibility of power surges, or outages.
-  Do not use if there is a possibility of weather related damage to the elevator equipment or hoistway (i.e.: flooding, shifted or tilting hoistway walls).
-  Do not use your elevator if the gate switches or hoistway door locks are not operating properly. Call your dealer or serviceman at once.
-  Never extend any part of the body or objects through the gate(s) while operating.
-  Safe operation requires a maintained hoistway temperature of between 60° - 110°F.
-  Do not expose electrical components to the elements or extreme temperature fluctuations. Resulting condensation will damage equipment, causing it to malfunction. If exposed, let sit for 12-24 hours prior to operation.

---

## Safety Features

Your Waupaca Elevator is equipped with many safety features you should be aware of.

- **Final Limit Switch.** Stops the elevator if it travels beyond its preset limits.
- **Slack Cable Safety.** Stops the elevator if one or both of the cables slacken or break.
- **Slack Cable Safety Switch.** Prevents the elevator from traveling if the cables slacken or break.
- **Car Gate Safety Switch.** The elevator will not operate if a gate is open.
- **Hoistway Door Interlocks.** The elevator will not operate if a hoistway door is open.

**DO NOT TAMPER WITH ANY SAFETY FEATURE!**

---

## Assumption of Risk

ALL PERSONS who use this Elevator bear the responsibility for proper use of this product.

Misuse, deliberate or otherwise, voids all warranties... written or expressed!

Waupaca Elevator Company, Inc. is NOT responsible for any injury or death resulting from product modification, additions or other changes which take place after the product has left the manufacturer's plant.



---

# Basic Operating Instructions

Due to the unique custom programming capabilities of the Paca-Lift Elevator, gate operation may vary.

- \_ Operation A -The gate will close shortly after the hallway door is closed.
- \_ Operation B - The gate will wait to close until the passenger signals his/her readiness by pushing a numbered floor button from within the elevator. If the elevator is not in use, the gate may remain open until called to a new floor, at which time it will close and proceed to the called floor.
- **Press the “Call” Button.** This will call the elevator to your floor. The elevator may immediately begin traveling or it will wait for the gate to close before traveling to your floor.
- **Open the Entry Door.** Open the door once the elevator has come to a complete stop on your floor.
- **Check for Leveling.** Visually verify the elevator is leveled properly, to avoid tripping or falling.
- **Opening of the Gate.** Your Paca-Lift has an automatic gate operator which will automatically open the gate.
- **Enter the Elevator.**
- **Close the Entry Door.** The elevator will not operate unless the door is completely closed.
- **Closing of the Gate.**
  - Operation A- Gate operator will automatically close the gate.
  - Operation B - Gate will close after a call is registered.
- **Press the Desired Floor Button.**
- **Complete Stop.** Wait for the elevator to come to a complete stop.
- **Exit Elevator.** Once gate has automatically opened, check for leveling before stepping out of the elevator.
- **Close Entry Door.** Firmly close the entry door as you exit the elevator. The elevator will not respond to another call if the entry door is not completely closed. The gate operator will automatically close the gate according to its programming.

Note: The descriptions and specifications contained in this guide were in effect at the time the guide was approved for printing. Waupaca Elevator Company reserves the right to discontinue models without notice and without incurring obligation. The equipment described within this guide may not be identified as either standard or optional and the various illustrations may not all be applicable to your particular unit. If you have questions, always check with your Elevator Contractor.



## Descriptive Features

It is important that you familiarize yourself with the features of your new Waupaca Paca-Lift Elevator before using.

## Hall Station

Hall Station should be located near the hoistway door.

- **Car “Call” Button.** Press this button to call the car to your floor. The button will light up while the elevator is in motion.
- **“Car Here” Button.** If present, this button will light up when the elevator has reached your floor.
- **Keylock.** Some hall stations may be equipped with an optional, keylock. The key must be turned on for the button to become active.
- **Maintenance.** Clean your hall station call plate with a clean cloth. Do not use harsh chemicals or abrasive cleaners.



## Car Operating Panel

Used to operate the elevator from within the car. Press and release a numbered button to send it to that floor.

- **Buttons.** Buttons will momentarily luminate when depressed.
- **Position Indicator.** When a floor is called the corresponding button will flash twice. Each floor button will illuminate as the elevator passes that floor until the destination is reached.
- **Alarm.** When pressed, the alarm button rings a bell alerting others within the home to your need for assistance.
- **Emergency Stop Button.** Immediately stops the elevator.
- **Light Switch.** A light switch for your convenience comes standard on all car operating panels.
- **Keylocks.** Optional Keylocks may be added for controlled access and safety.
- **Maintenance.** Clean your car operating panel faceplate with a clean cloth. Do not use harsh chemicals or abrasive cleaners.





## Telephone Jack

- **Telephone Jack.** All Waupaca elevators are equipped with a telephone jack. Some elevators are equipped with an optional Flush Mount telephone box (shown here).
- **Maintenance.** Periodically check to make certain the telephone is in good working order.



**GAL KEY**



**EMI KEY**

## Hoistway Door Interlock

Locks the hoistway door when the car is not at that landing. Located inside the hoistway at the top corner on the latch side door jamb.

- Surface mounted mechanical interlock.
- **Emergency Key.** Can be used to open the door from outside the hoistway in case of emergency or for servicing. **This key is to be used only for emergencies.**
- **GAL Interlock.** Insert the emergency release key into the hole (near the top of the door) and turn (toward the center of the door) to release the interlock while opening the door.
- **EMI Interlock.** Insert the emergency release key into the hole (near the top of the door) and pull center downward to release the interlock while opening the door.



## Accordion Gate

The Accordion Gate secures the car opening during operation. This gate provides a solid barrier between the car and the hoistway, preventing items from accidentally protruding into the hoistway during operation. The Accordion gate is standard on all cars.

- **Maintenance.** Dust and/or clean the panel surfaces with a clean cloth. Do not use harsh chemical or abrasive cleaners. Keep the gate track clear of dirt or debris.



## Power Gate Operator

Automatically controls the opening and closing of the accordion car gate.

- **Convenience.** One less step to remember during the operation of your new elevator. The hands free advantage is very helpful for those with limited mobility and strength.
- **Out of Sight.** The power gate operator is mounted on the top of the elevator car.

---

# Troubleshooting

## **Before Calling for Service...**

Verify that all gate(s) and doors are securely closed. The elevator will not operate if a gate or door is even partially open.

Check the red Emergency button by pulling and then pushing the button back into proper running position.

Do not attempt to repair the elevator yourself. Trained technicians can safely, and quickly, determine the problem and the correct solution.

Pushing call buttons or floor buttons repeatedly will delay operation and potentially shut down controls.

**If your elevator still will not function  
call your elevator contractor immediately.**



# EMERGENCY PROCEDURE

**⚠** These **EMERGENCY PROCEDURES** should only be used during an emergency. If you are experiencing repeated stalling call for service immediately.

Remember, the first step in an emergency should always be to call for help on the telephone.

**⚠** Be sure the Emergency Stop Button is in the “OFF” position. Severe injury could result if the elevator should start up in the middle of an emergency extraction.

## Emergency Extraction

### Battery Lowering Feature -

When an elevator loses main power, the battery will continue powering the unit for one half hour. The battery lowering feature will only allow the elevator to be lowered (not raised) to any floor below its current position.

### Manual Operation -

- ⚠** If the cables are slack or mis-grooved, manual operation should not be attempted, call for service immediately!
- ⚠** The service disconnect (located in the control space) must be in the “OFF” position before using the hand wheel. Keep all loose/dangling items (neck ties, long hair, jewelry, etc.) away from the powerhead. If the unit is accidentally started while using the hand wheel, severe injury could result!

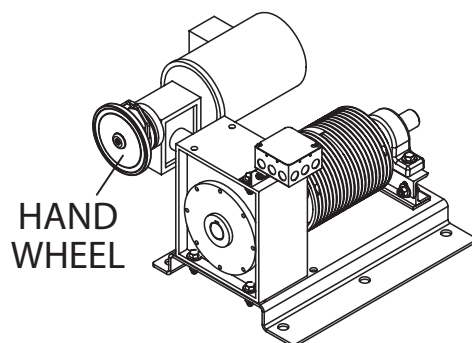

If your Paca-Lift stalls between floors and there is help available, have them follow the emergency extraction procedure below:

- ⚠** Verify that the service disconnect is in the “OFF” position.
- ⚠** Turn the hand wheel to the desired hoistway landing (downward is easier).
- ⚠** Do not use.
- ⚠** Call for immediate servicing of elevator before continuing to use/operate the elevator.

## Emergency Opening of the Hoistway Door from Outside the Elevator

To release the interlock and open the hoistway door, the procedure for releasing the interlock will depend on which type of interlock is used with the elevator. Both interlocks are designed to be opened from outside of the hoistway door. To open the hoistway door Waupaca Elevator Company recommends the following procedure:

### EMI Interlock

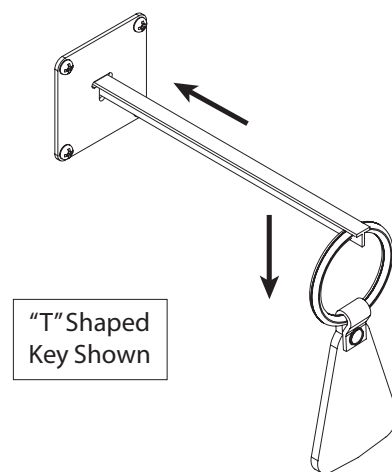

If your elevator is equipped with a Waupaca Electro-Mechanical Interlock (EMI) use the key provided to open the lock from the outside of the hoistway. To open the door insert the key thru the hole in the hoistway door until the handle contacts the door. If there is no hole in the hoistway door proceed to the instructions for unlocking the door from the inside of the car. Gently pry the outboard end of the key to lift the interlock pin. Slowly open hoistway door with interlock pin raised.

- Call your dealer for service before using the elevator again.

### GAL Interlock

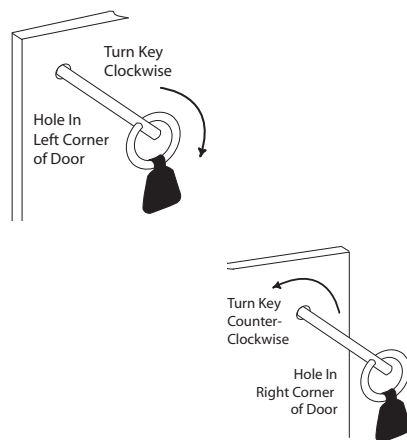

If your elevator is equipped with a GAL "N" Type Interlock, use the key provided to open the lock from the outside of the hoistway. Insert the emergency release key into the hole (near the top of the door) and turn (toward the center of the door) to release the interlock while opening the door.

- Call your dealer for service before using the elevator again.

## Emergency Opening of the Hoistway Door from Within the Elevator

If no one is available to open the hoistway door from outside of the car it can be opened from the inside with some risk to the occupants. Remember to first...

Use the phone to call for help before attempting to open the hoistway door from within the elevator.

**⚠** Be sure the Emergency Stop Button is in the "STOP" position. Severe injury could result if the elevator should start up in the middle of an emergency extraction.

### EMI Interlock

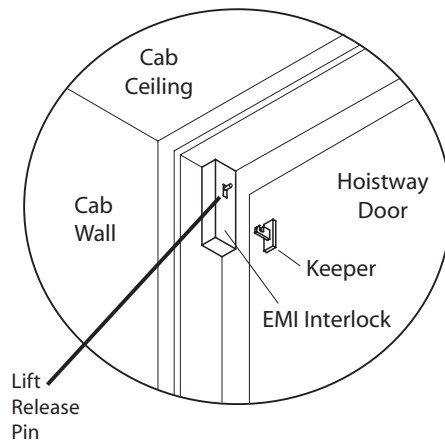

**⚠** Verify that the emergency stop button is in the "OFF" position.

To open the hoistway door from within the car:

- Open the car gate
- Lift the release pin and open the hoistway door while the pin is lifted.

### GAL Interlock

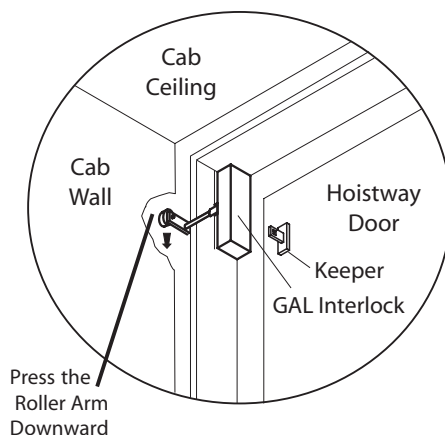

**⚠** Verify that the emergency stop button is in the "OFF" position.

To open the hoistway door from within the car:

- Open the car gate
- **CAREFULLY** reach into the hoistway, press down on the roller arm
- Open the hoistway door while holding down on the roller arm

## LIMITED WARRANTY

This product **Paca-Lift Elevator**, the Serial Number of which is \_\_\_\_\_, is subject to a Limited Warranty (as defined below) by Waupaca Elevator Company, Inc. (WECO). It applies for the earlier of:

1. Two (2) years from the date of installation, up to a maximum of thirty (30) months from the date of shipment from the factory provided the warranty card has been filled out and returned; or
2. Twenty-Four (24) months from the date of shipment from the factory if the warranty card has not been filled out and returned.

This Warranty is LIMITED. It covers any electrical or mechanical defects in material or workmanship, but does not cover any damage due to the following:

- (1) Accidents which are caused in whole or in part by someone other than WECO;
- (2) Damage due to improper or neglected lubrication, or lack of other maintenance;
- (3) Improper power supply;
- (4) Improper installation;
- (5) Improper use or abuse;
- (6) Repairs or replacements done by someone other than an authorized representative of WECO;
- (7) Alteration to the original design as manufactured by WECO.

This Limited Warranty does not cover costs of repairs made or attempted outside of the factory unless the repairs are authorized in advance **in writing** by WECO. This Warranty is VOID if any alterations are made to the product outside of the factory except as provided in this Warranty.

Any defective material or parts that are covered by this Warranty should be returned after first calling or writing WECO for a return shipping authorization and number, and mailing Postage Prepaid, to the following address:

WAUPACA Elevator Company, Inc.  
1726 Ballard Road • Appleton, WI 54911  
(800) 238-8739

The following written information must also be included with the returned parts: The authorized return material number, the product's serial number, the owner's name and address, and the dealer's name and address. Providing that an inspection by WECO shows the material or parts are defective as claimed, WECO will, at its option, either repair or replace (without charge) the material or parts. WECO is not responsible for any service or labor charges incurred in the removal and /or replacement of any parts covered by the Warranty.

NEITHER THIS WARRANTY NOR ANY OTHER WARRANTY, EXPRESS OR IMPLIED, INCLUDING ANY IMPLIED WARRANTY OF MERCHANTABILITY OR OF FITNESS FOR A PARTICULAR PURPOSE, SHALL EXTEND THIS LIMITED WARRANTY. NO RESPONSIBILITY IS ASSUMED FOR ANY INCIDENTAL OR CONSEQUENTIAL DAMAGES. SOME STATES DO NOT ALLOW LIMITATIONS ON HOW LONG AN IMPLIED WARRANTY LASTS AND SOME STATES DO NOT ALLOW THE EXCLUSION OR LIMITATION OF INCIDENTAL OR CONSEQUENTIAL DAMAGES, SO THE ABOVE LIMITATIONS OR EXCLUSIONS MAY NOT APPLY TO YOU. THIS WARRANTY GIVES YOU SPECIFIC LEGAL RIGHTS. YOU MAY HAVE OTHER RIGHTS, WHICH VARY, FROM STATE TO STATE.

Waupaca Elevator Company, Inc. • 1726 Ballard Road • Appleton, WI 54911







PM0005-A  
MARCH 2007

1726 North Ballard Road • Appleton, WI 54911  
Phone 920-991-9082 • [www.waupacaelevator.com](http://www.waupacaelevator.com)

